

RFYFA
PLAYBOOK
1st/2nd Grade



Playbook Overview



Balanced Formation

- Balanced means the Wide Receiver will line up to the right of the Center and the Flanker will line up to the left of the Center
- The Running Back will line up directly behind the Quarterback
- QB will be in shotgun formation
- On running plays all other players should run a “Go” route or “run off” the defenders in their part of the field

Twins Formation

- Twins means the Wide Receiver and Flanker will line up together on one side of the Center
- The Wide Receiver will be the player closest to the sideline
- The Flanker will be the player between the Wide Receiver and the Center
- The Running Back will line up directly behind the Quarterback
- QB will be in shotgun formation
- On running plays all other players should run a “Go” route or “run off” the defenders in their part of the field

1st/2nd Grade Route Tree

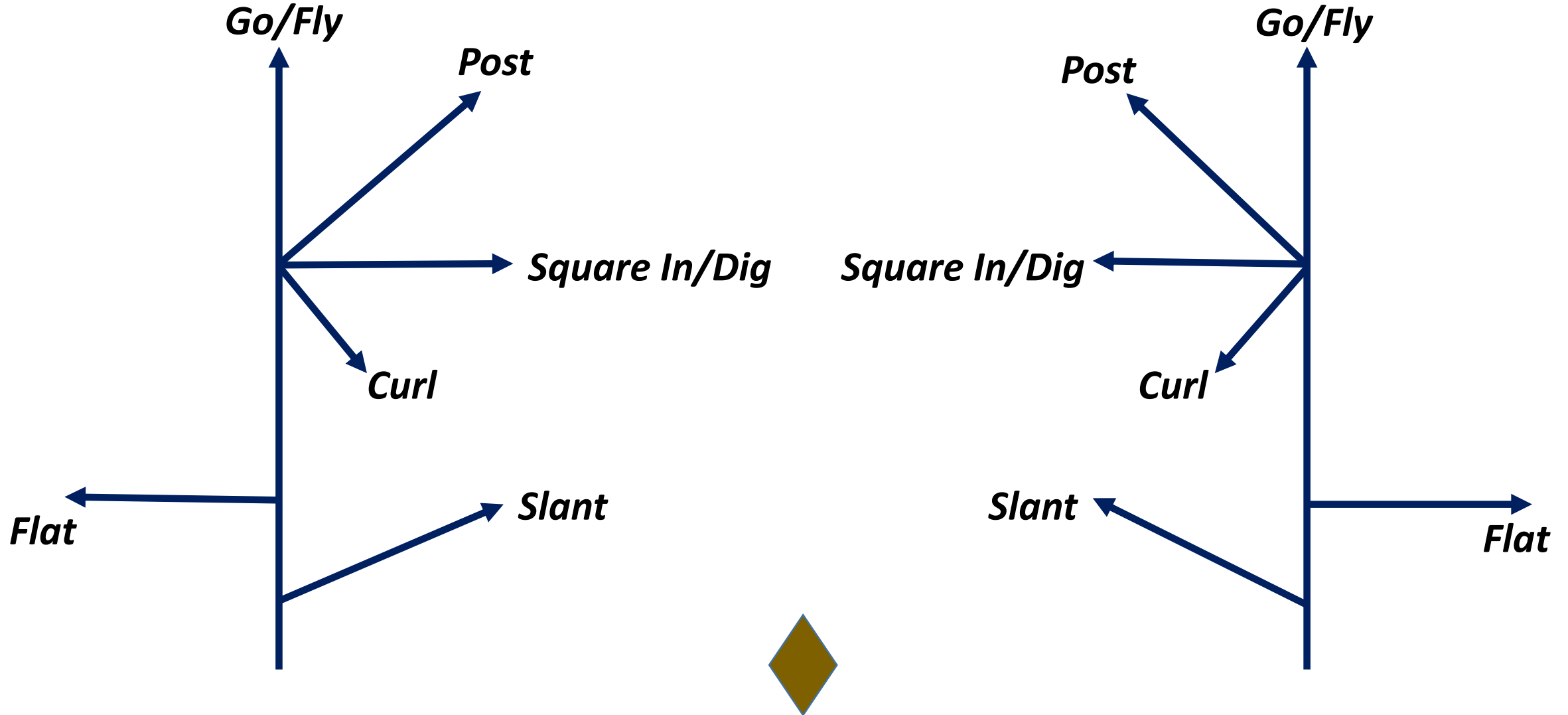

BALANCED, SWEEP LEFT

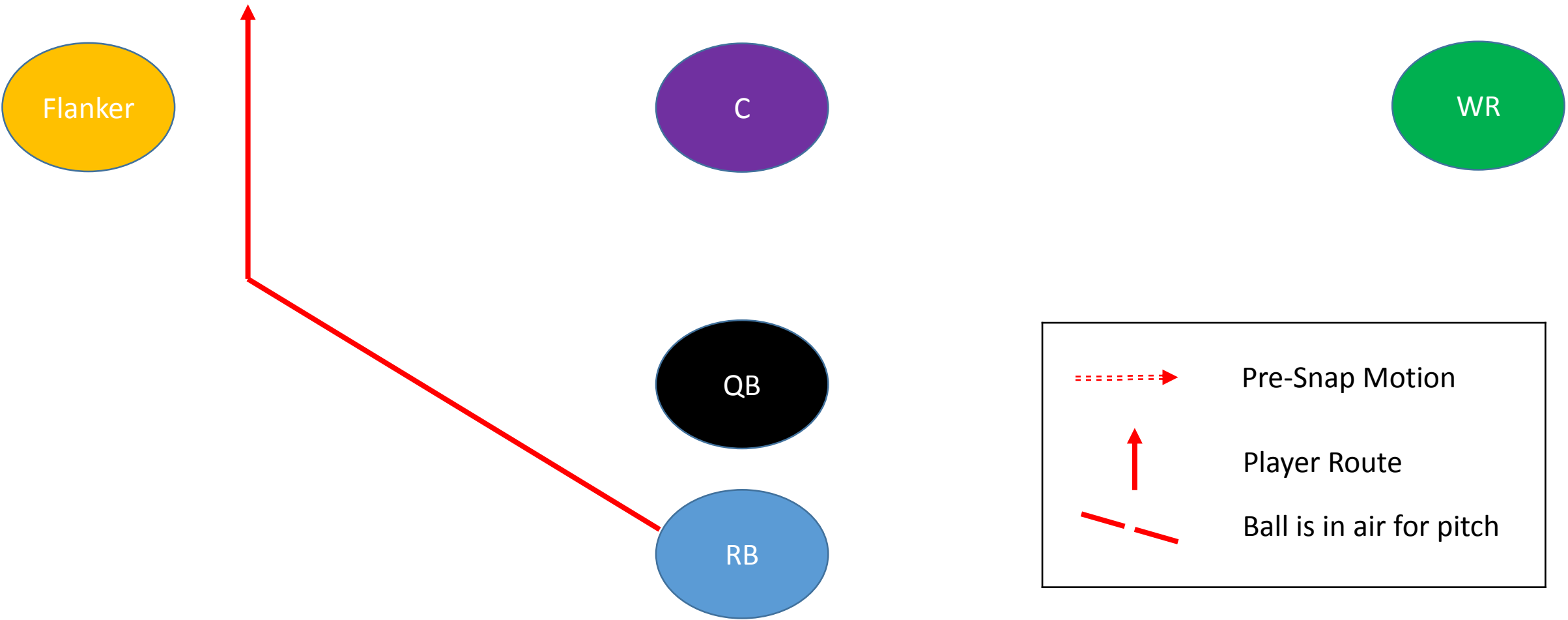

BALANCED, PITCH LEFT

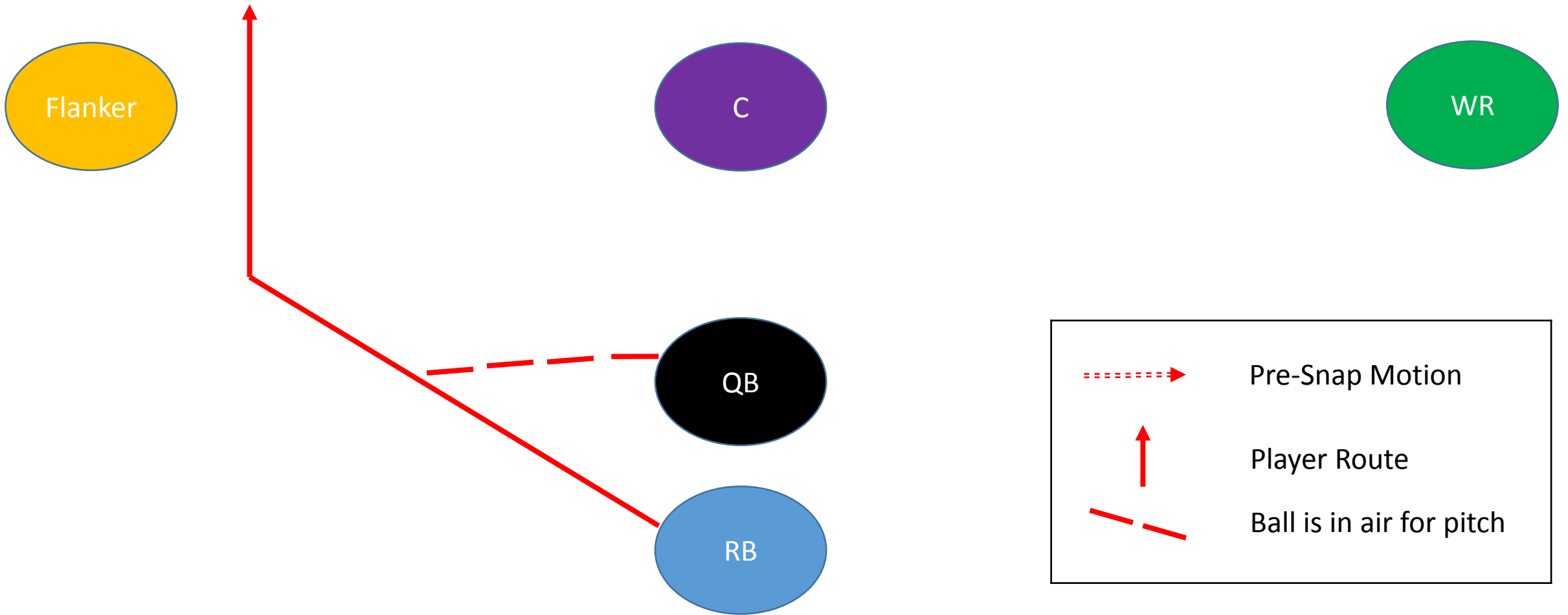

TWINS LEFT, SWEEP LEFT

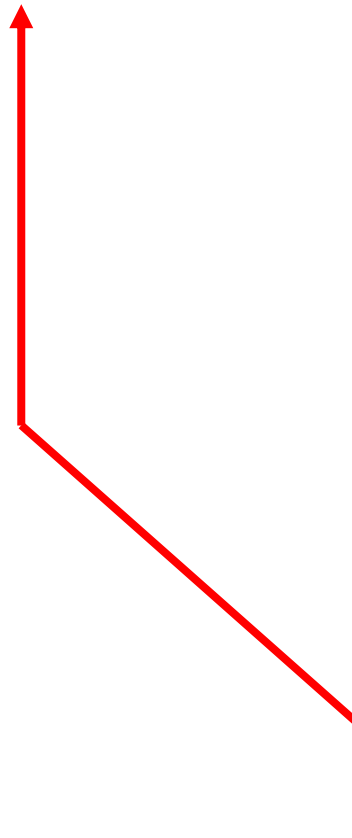
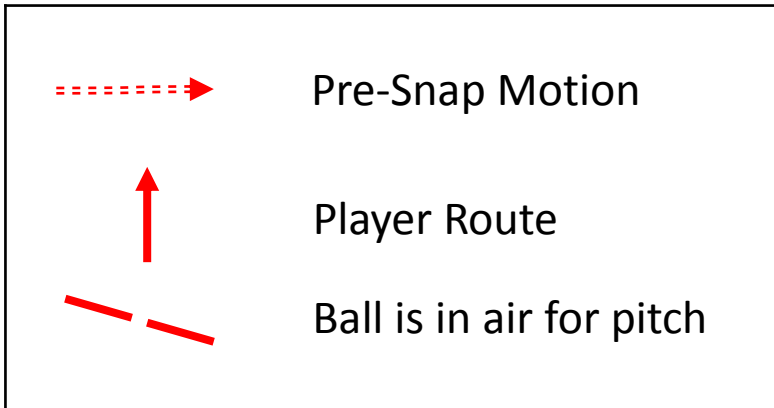
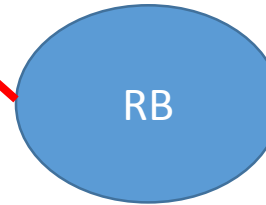
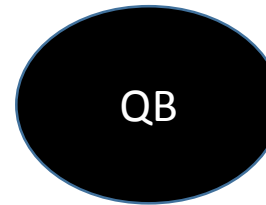
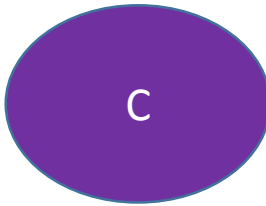

TWINS RIGHT, SWEEP LEFT

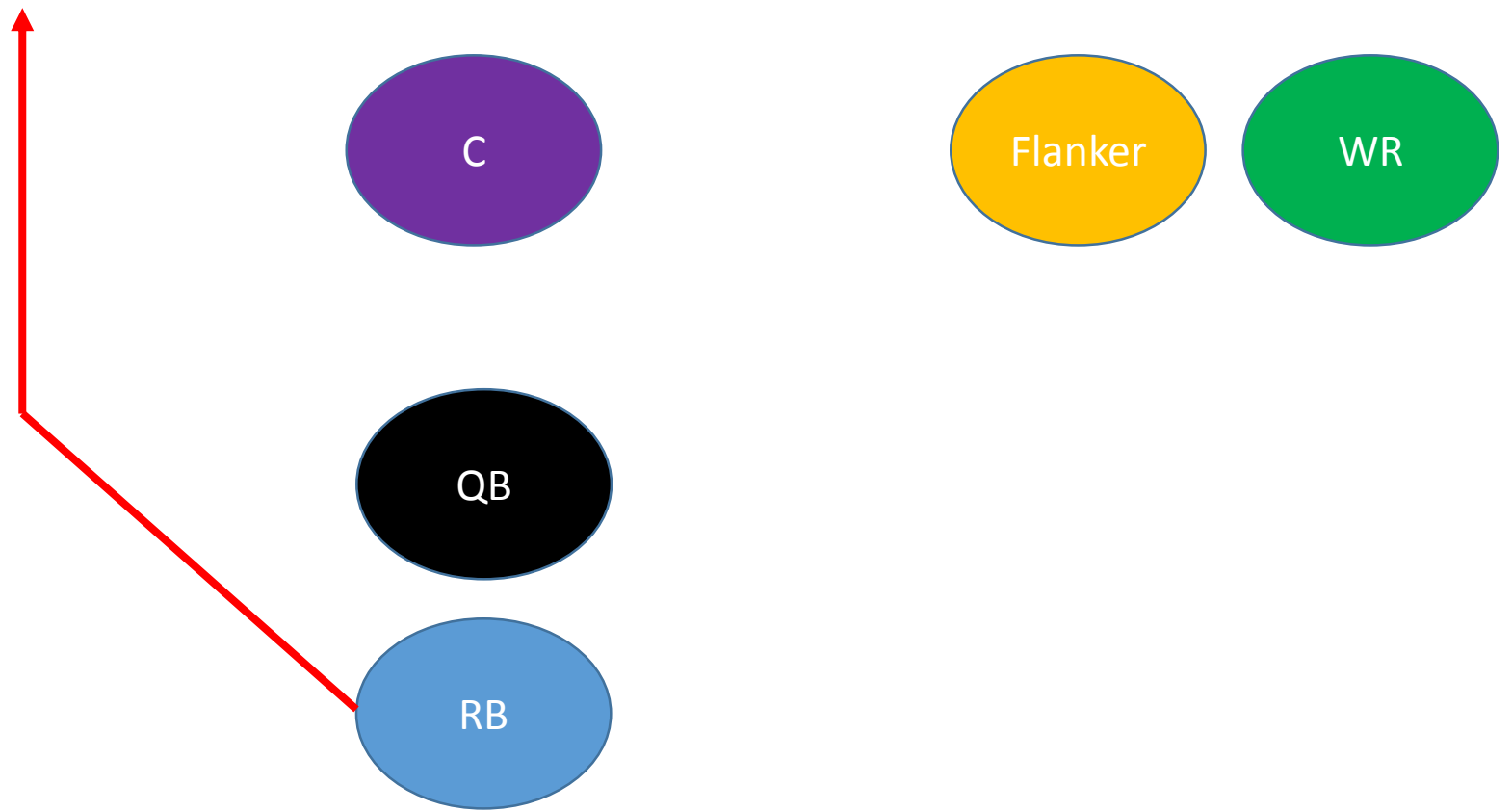
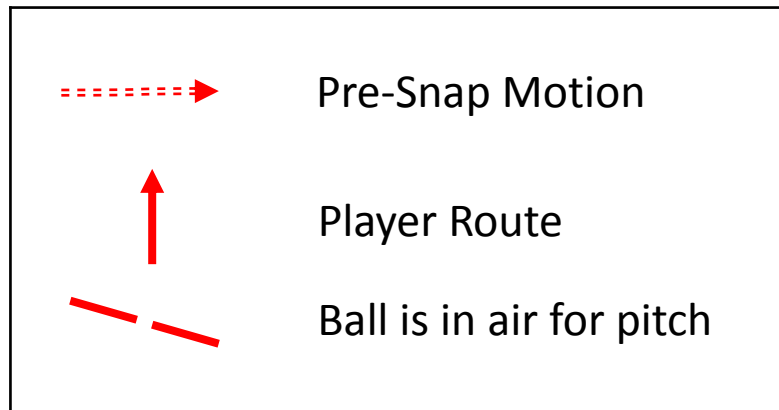

TWINS RIGHT, WR END AROUND

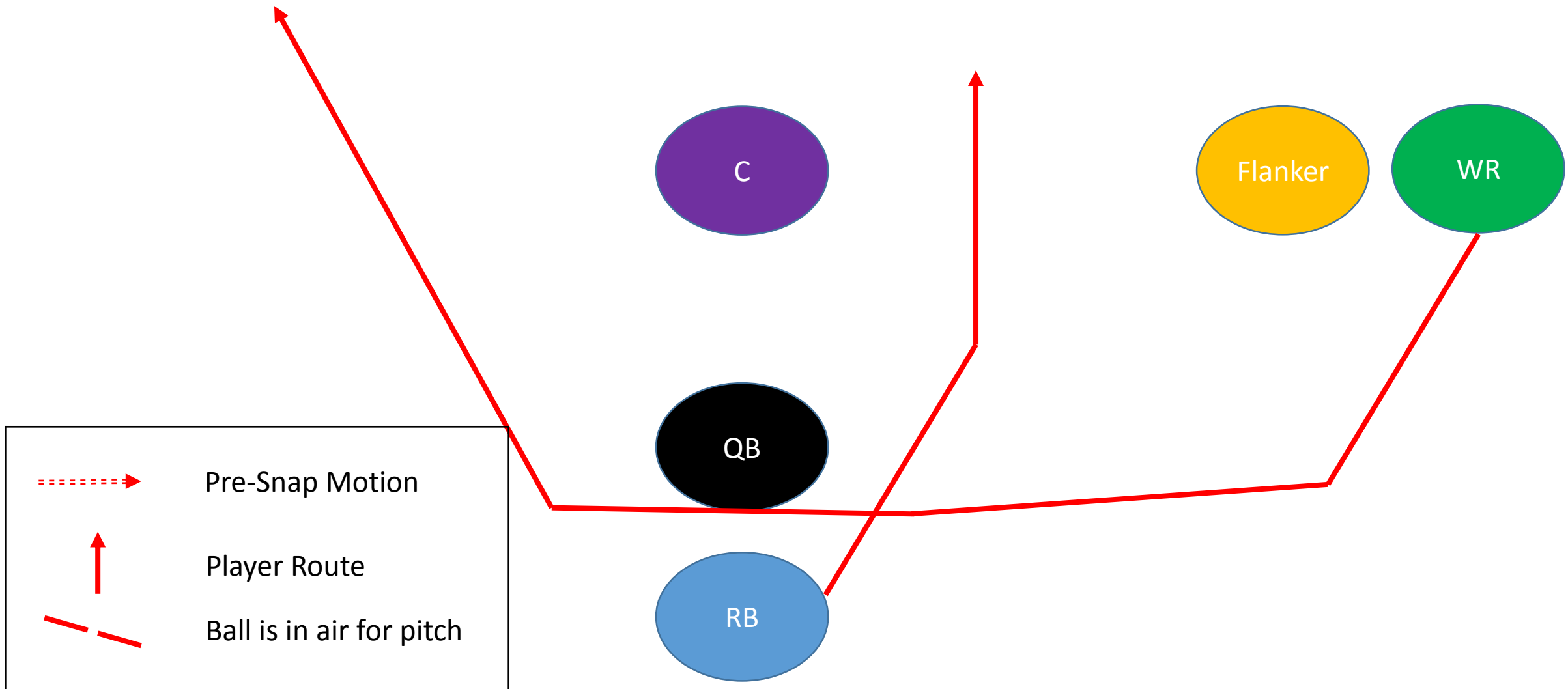

TWINS RIGHT, WR JET SWEEP

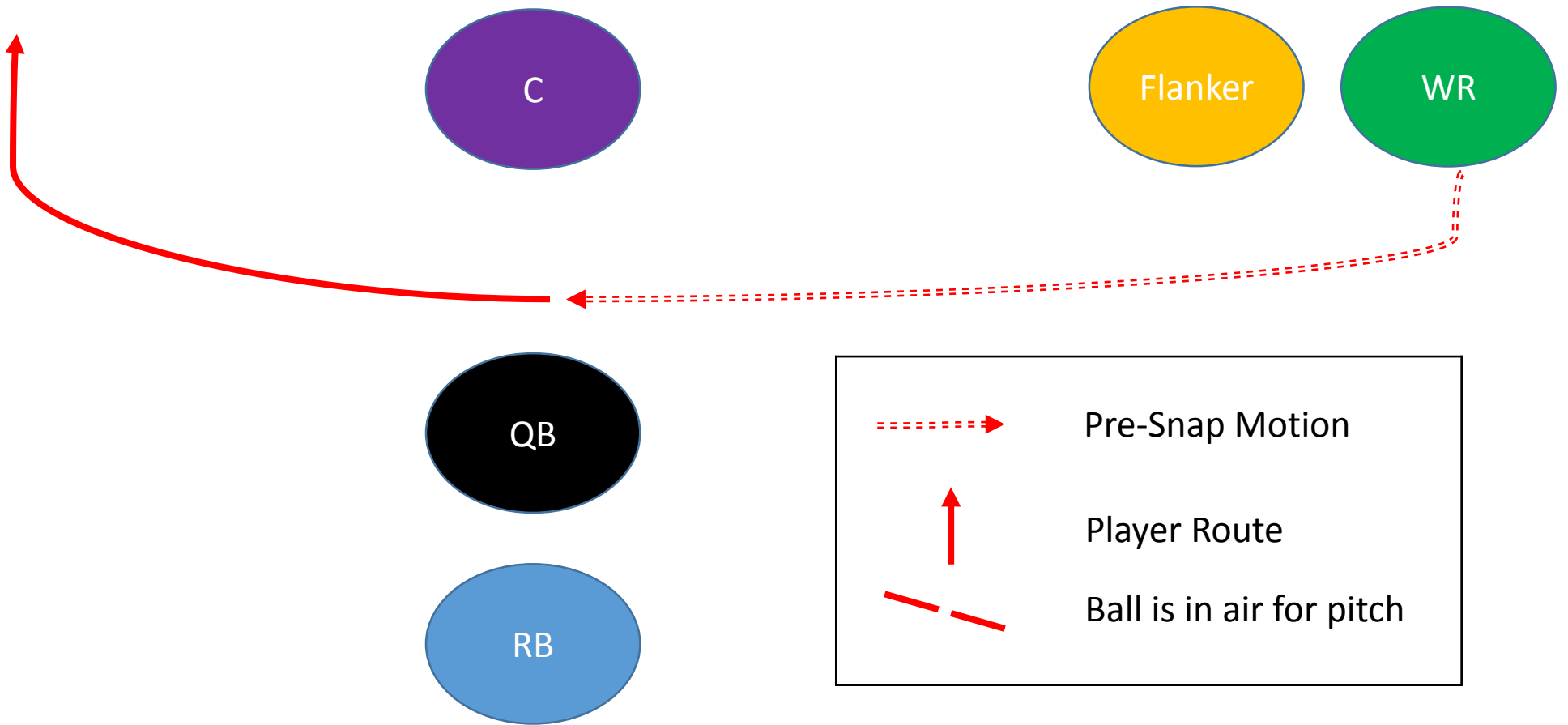

TWINS RIGHT, FLANKER JET SWEEP

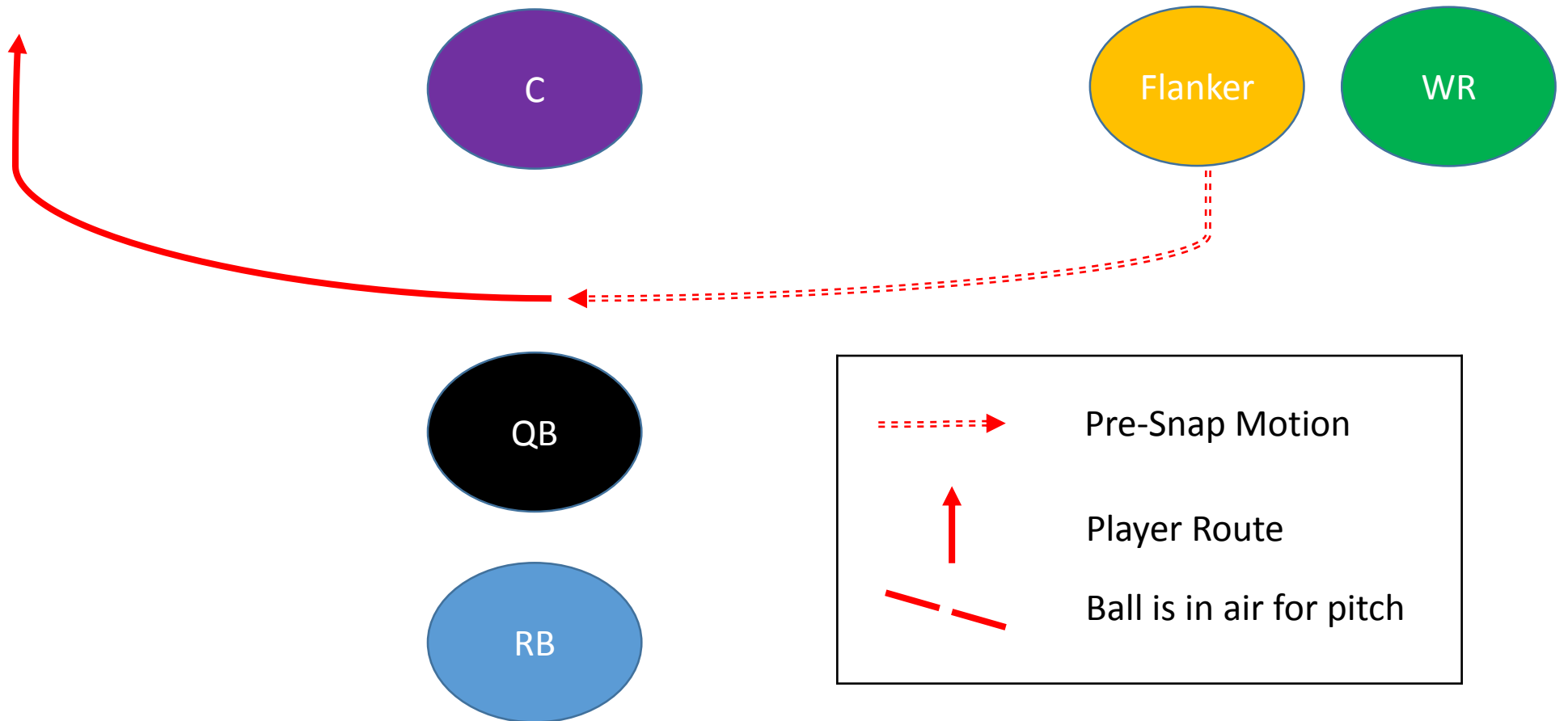

BALANCED, SWEEP RIGHT

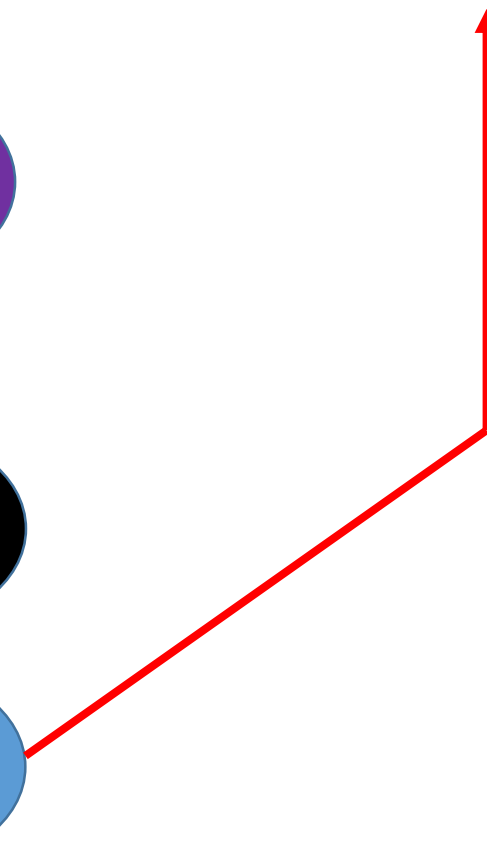
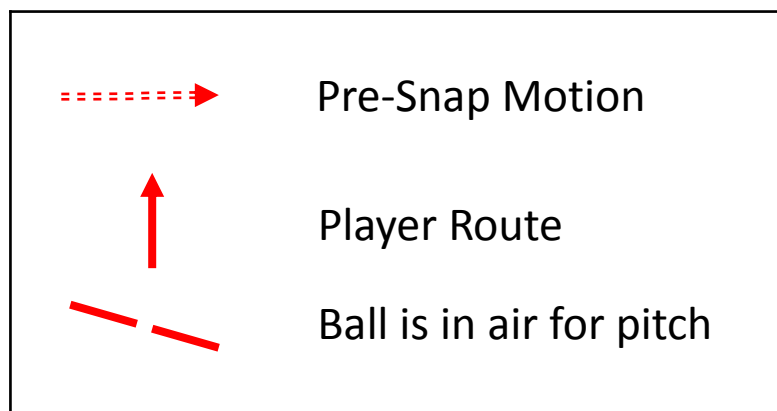
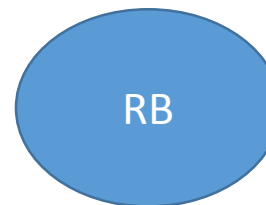
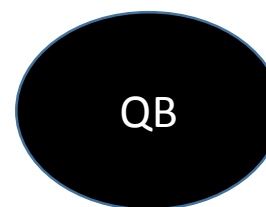
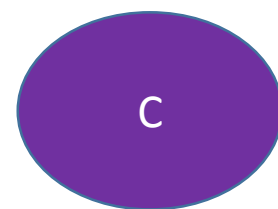
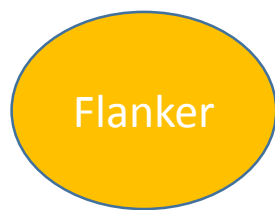

BALANCED, PITCH RIGHT

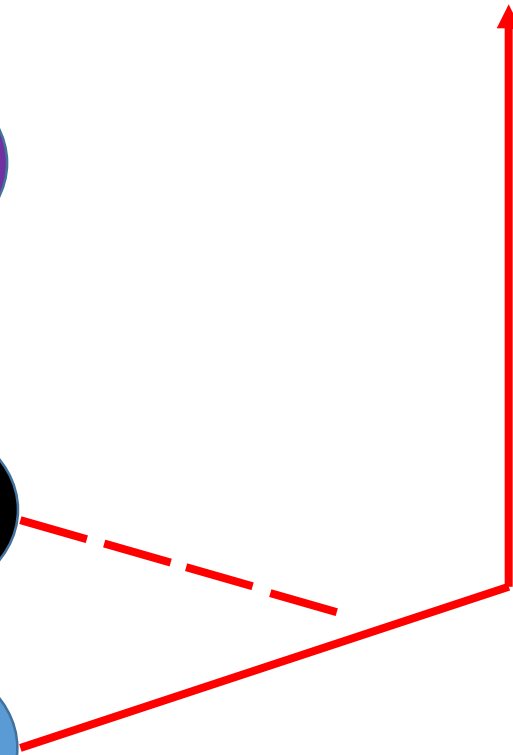
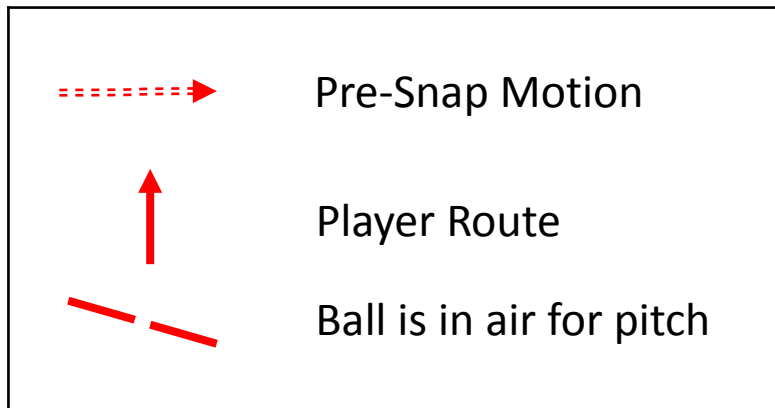
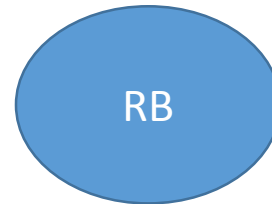
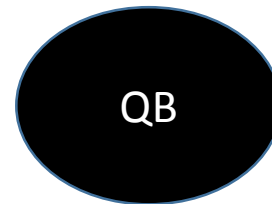
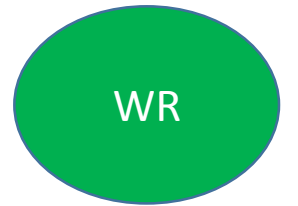
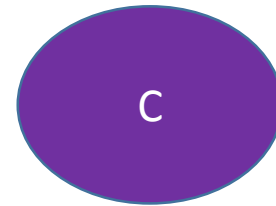

TWINS RIGHT, SWEEP RIGHT

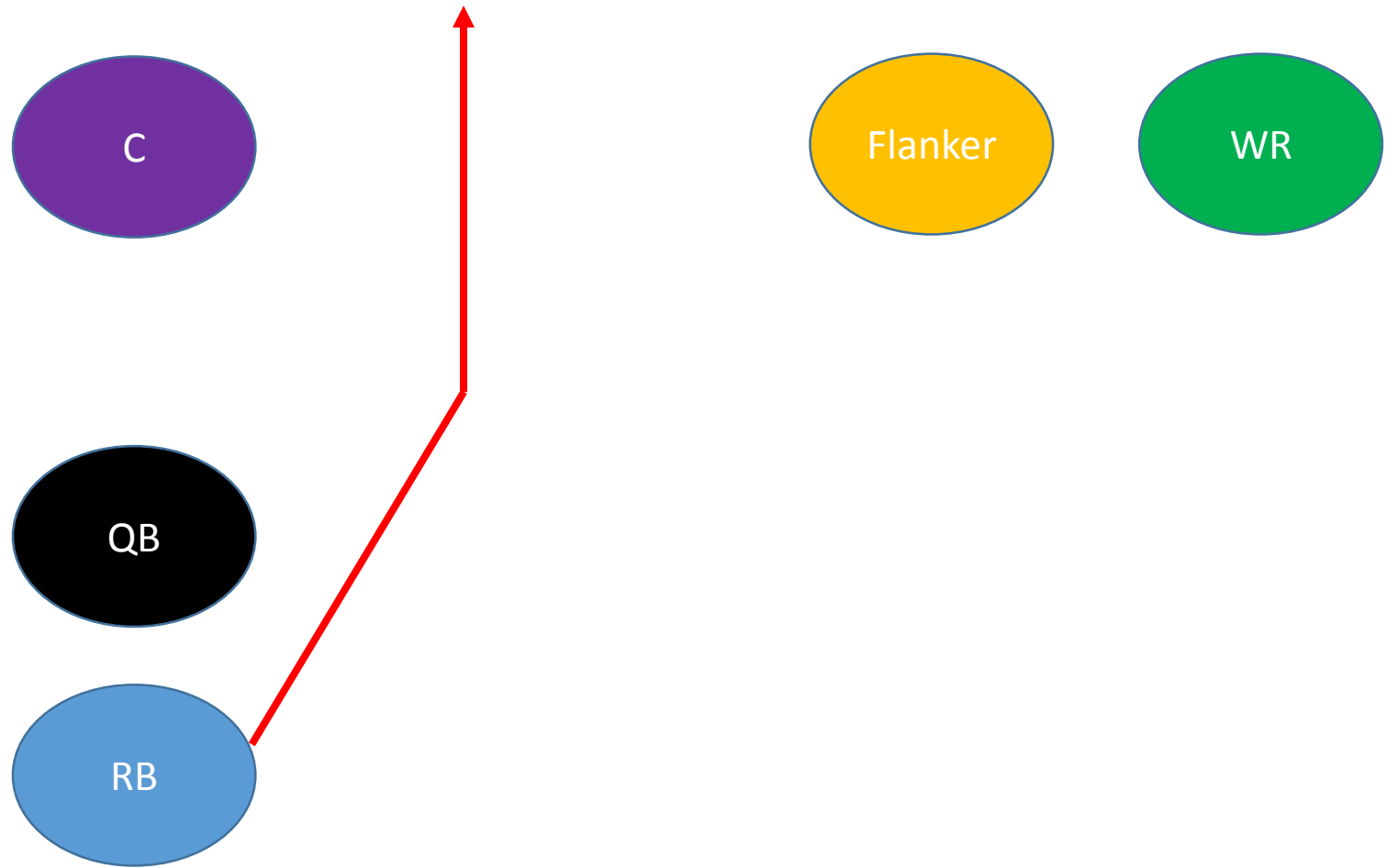
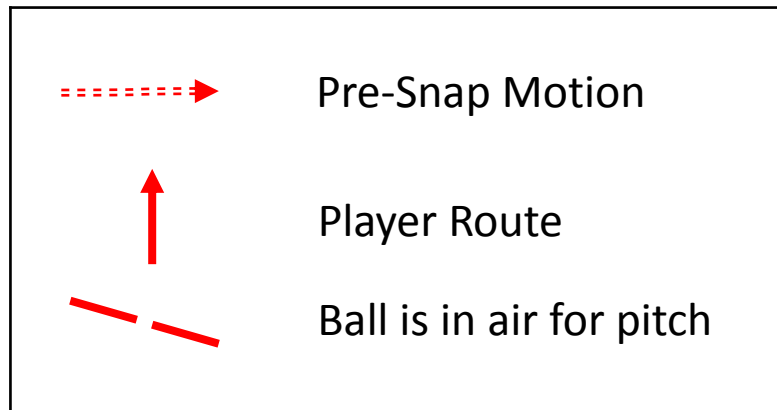

TWINS LEFT, SWEEP RIGHT

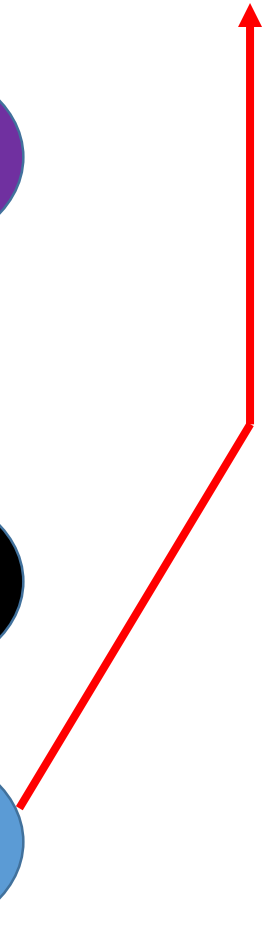
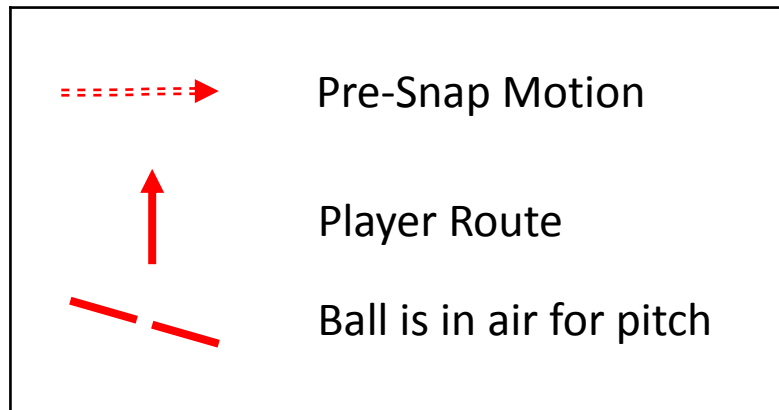
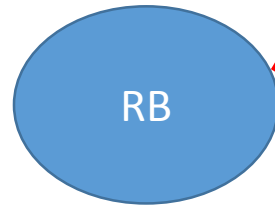
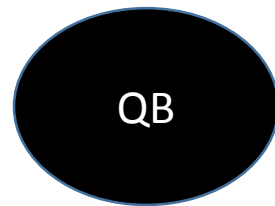
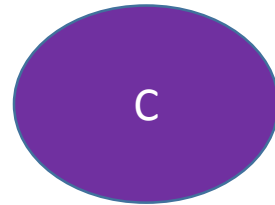

TWINS LEFT, WR REVERSE

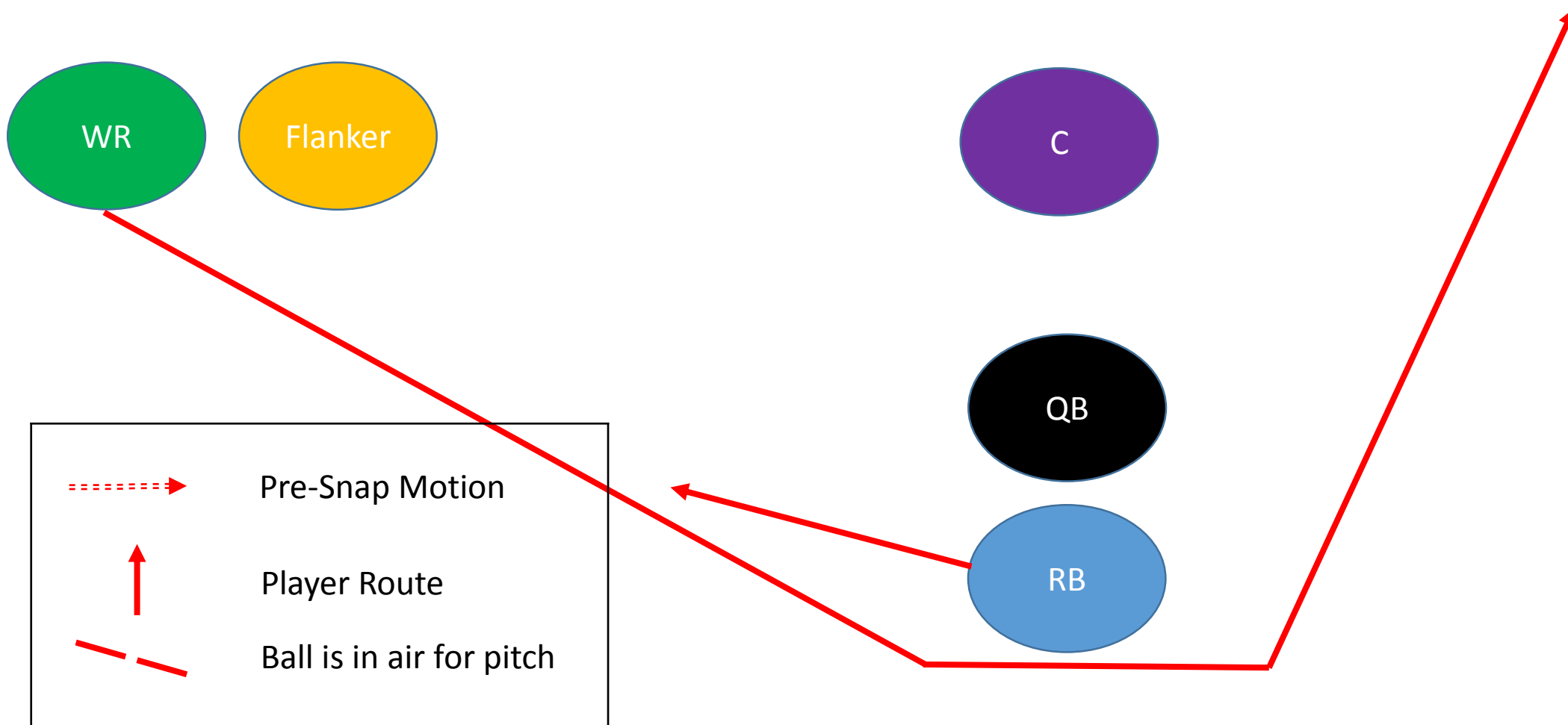

TWINS LEFT, WR JET SWEEP

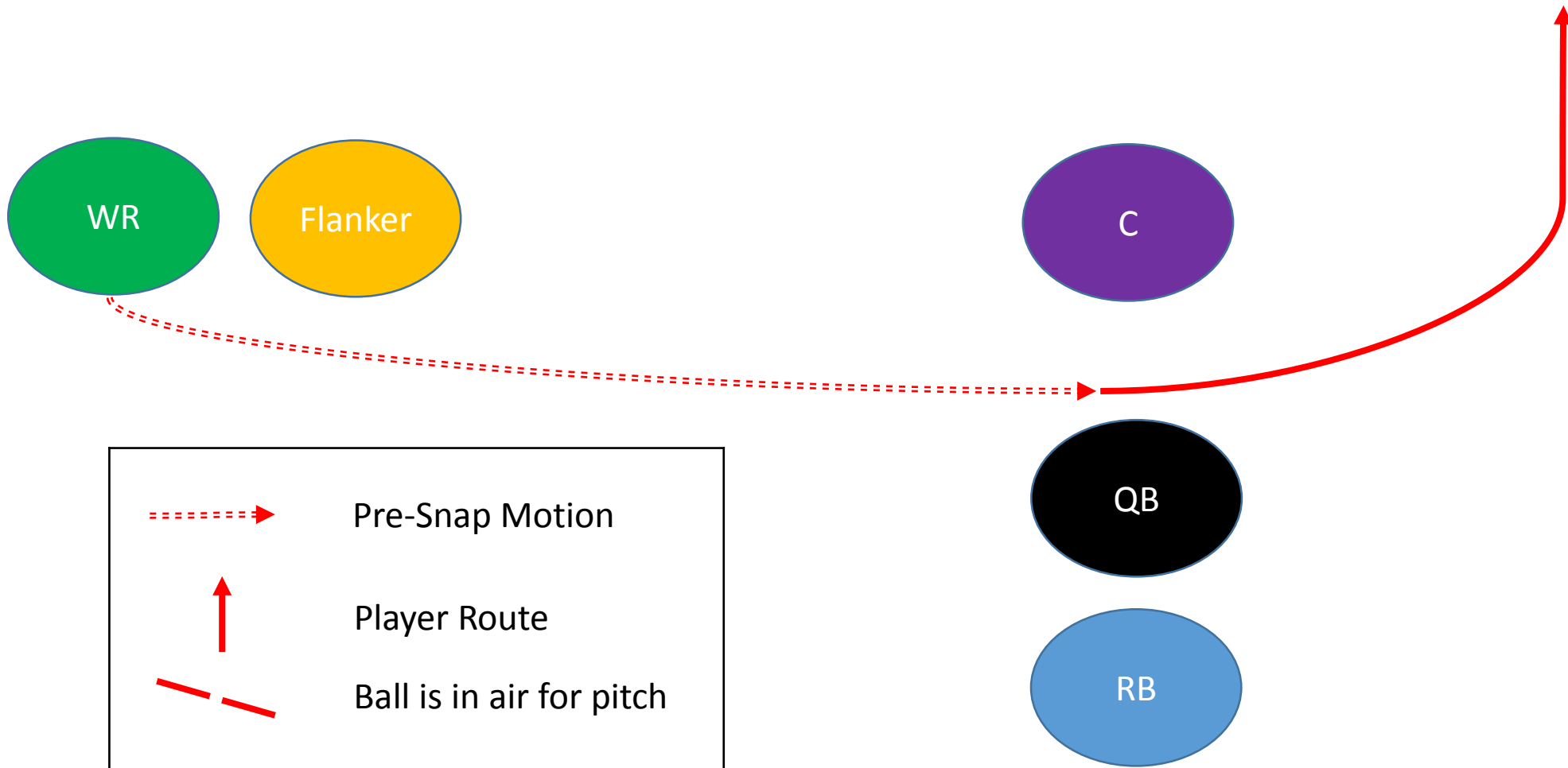

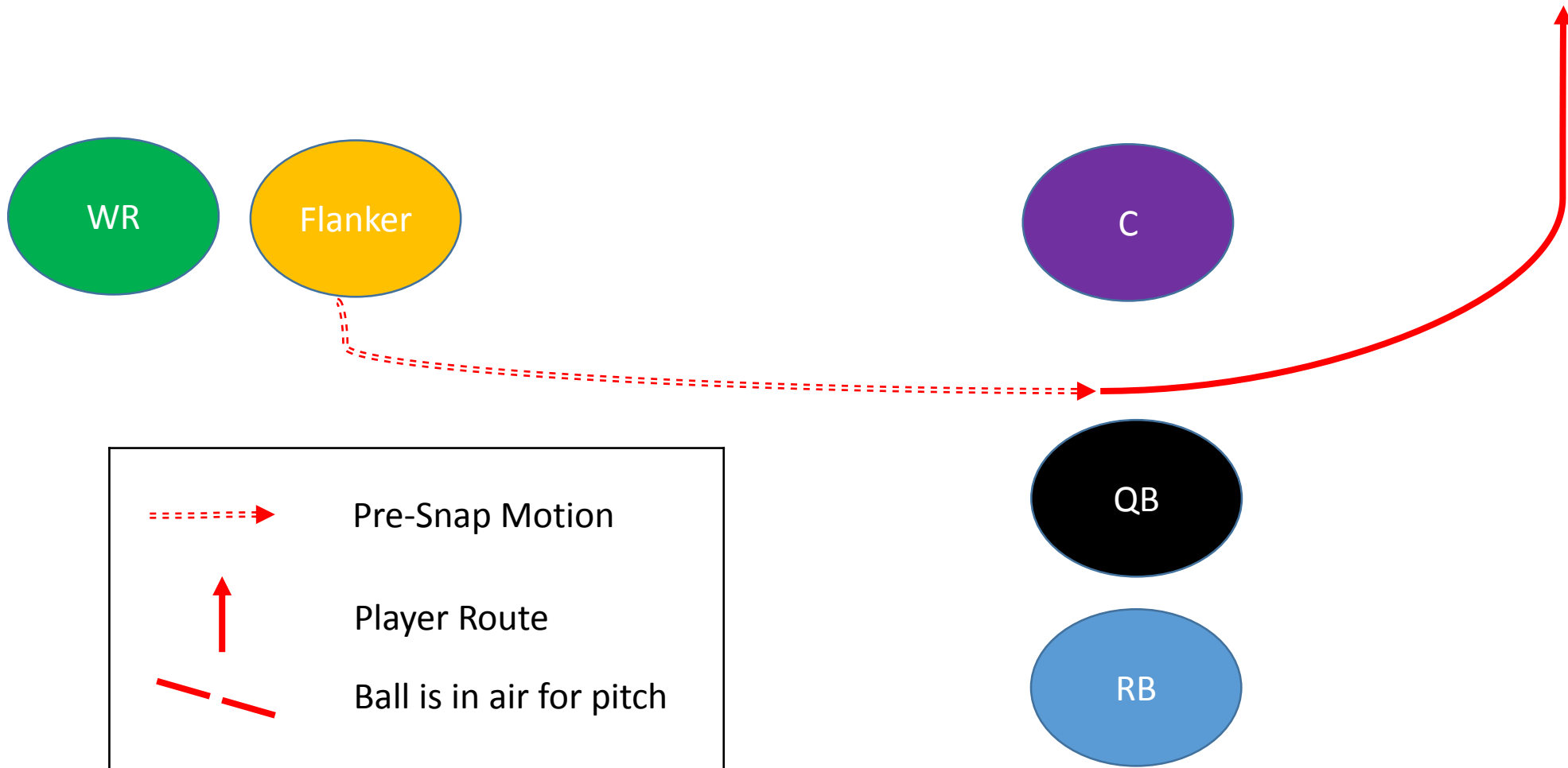

TWINS LEFT, FLANKER JET SWEEP

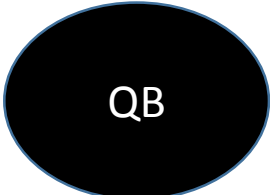
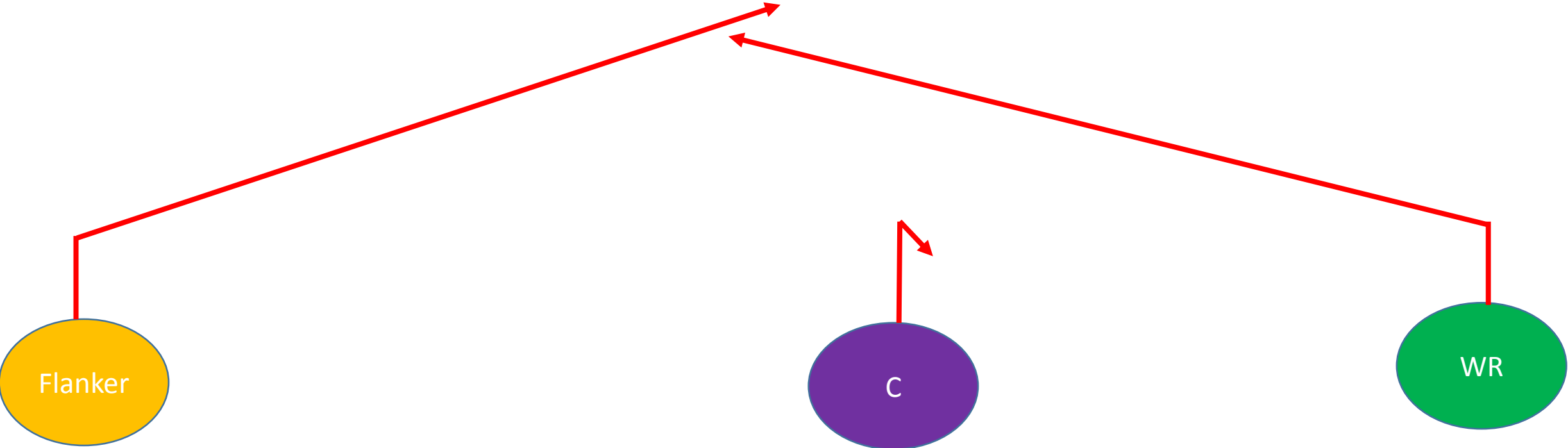

BALANCED, ALL SLANT



	Pre-Snap Motion
	Player Route
	Ball is in air for pitch



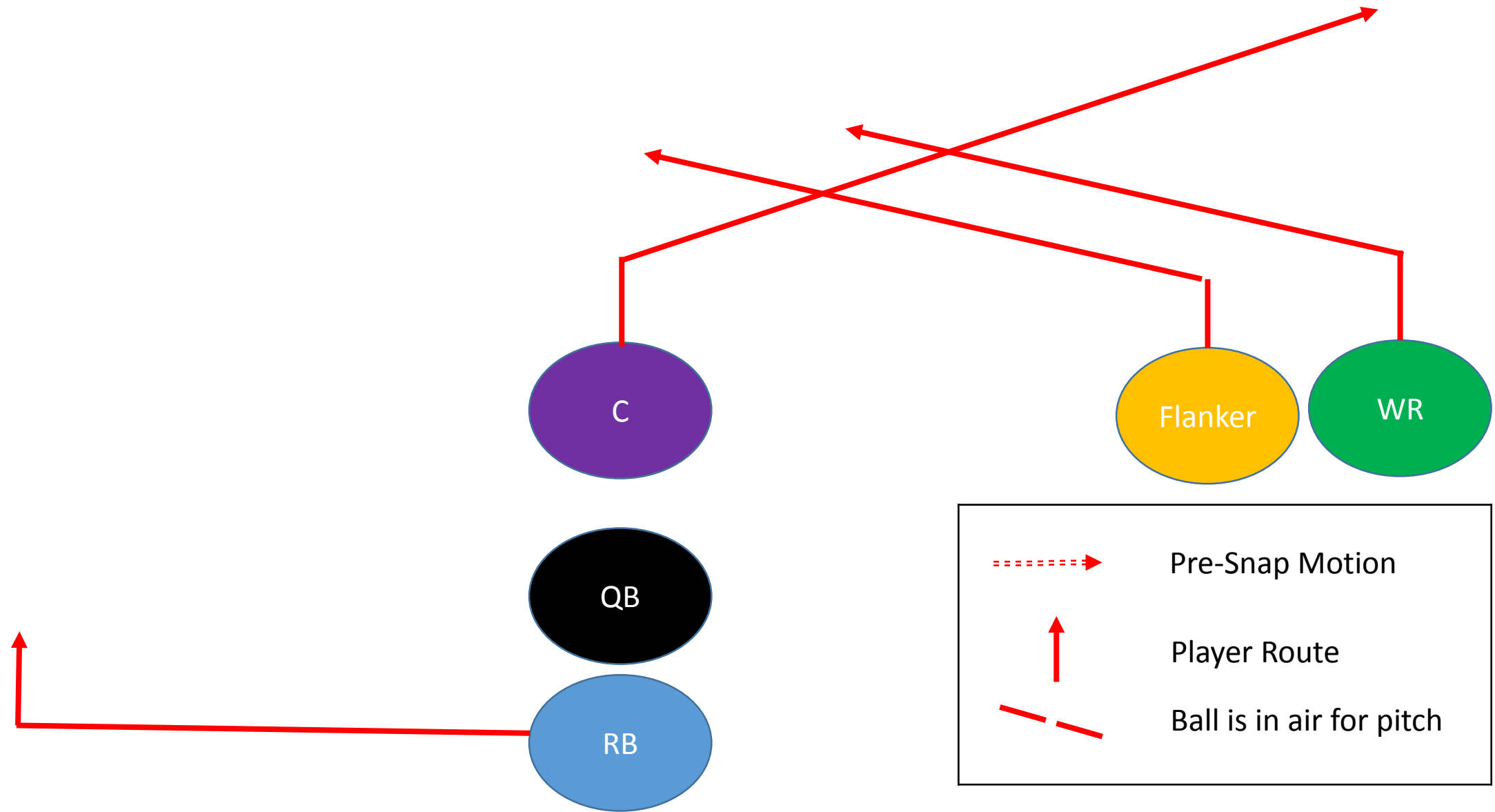

TWINS RIGHT, ALL SLANT

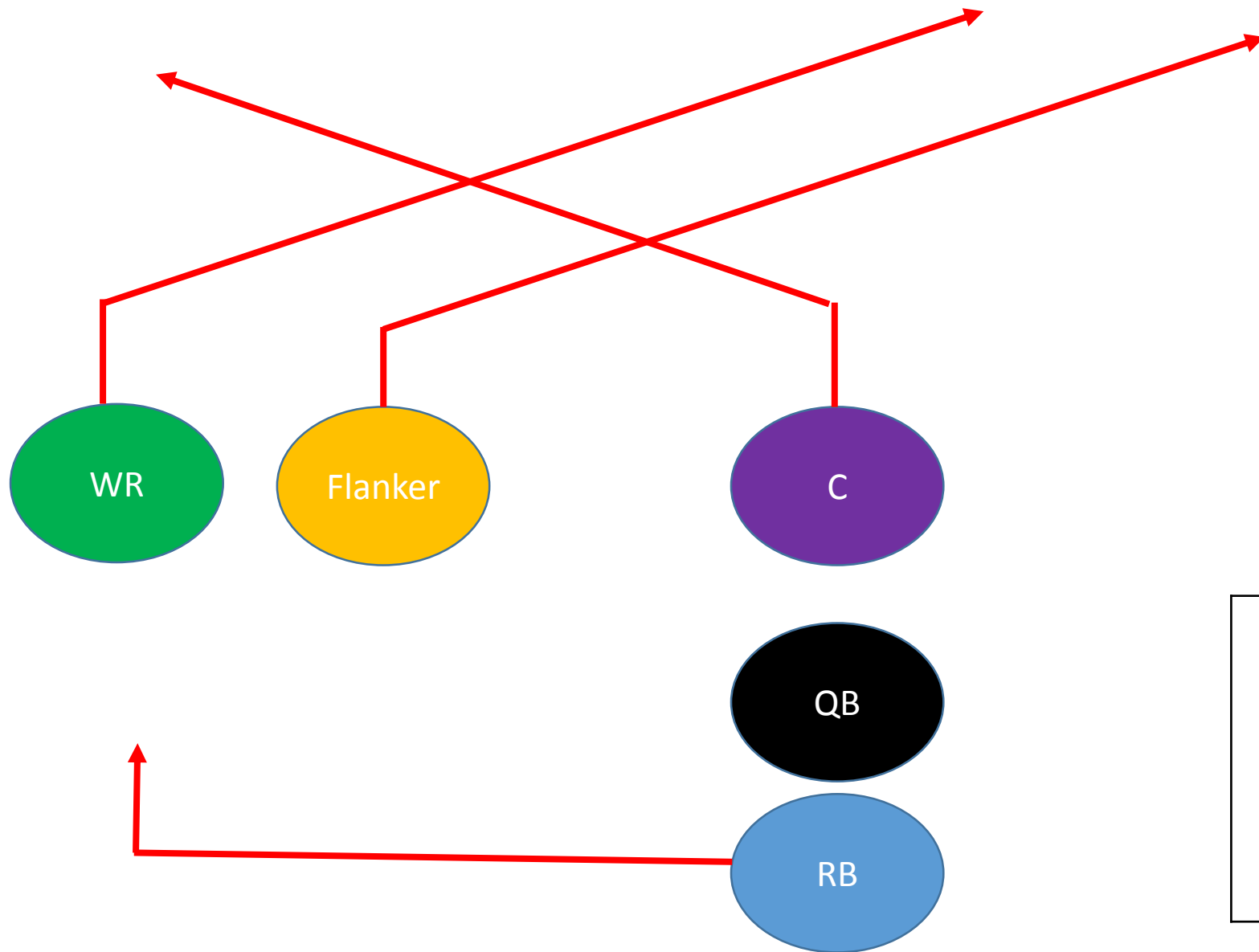

TWINS LEFT, ALL SLANT



	Pre-Snap Motion
	Player Route
	Ball is in air for pitch

BALANCED, ALL CURL

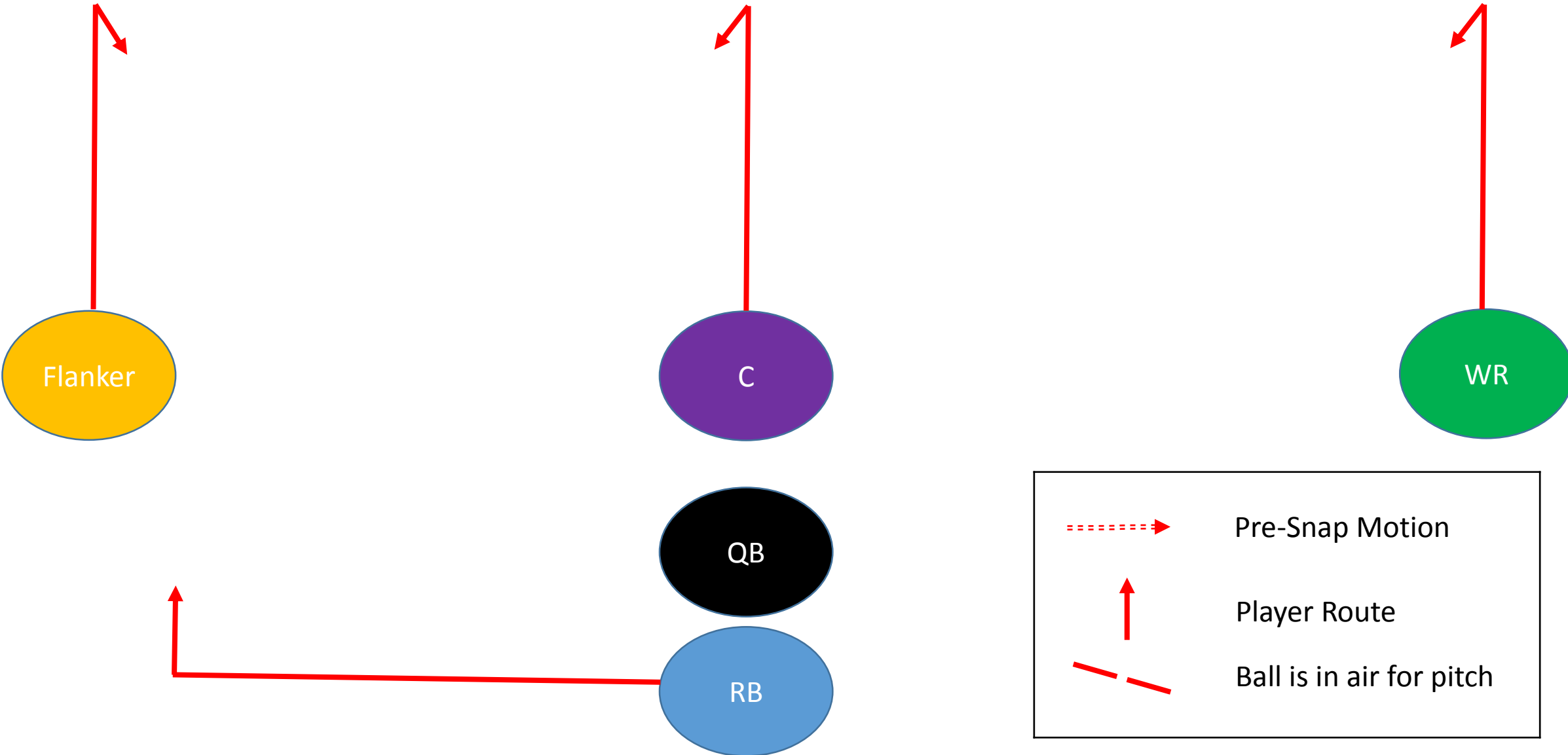

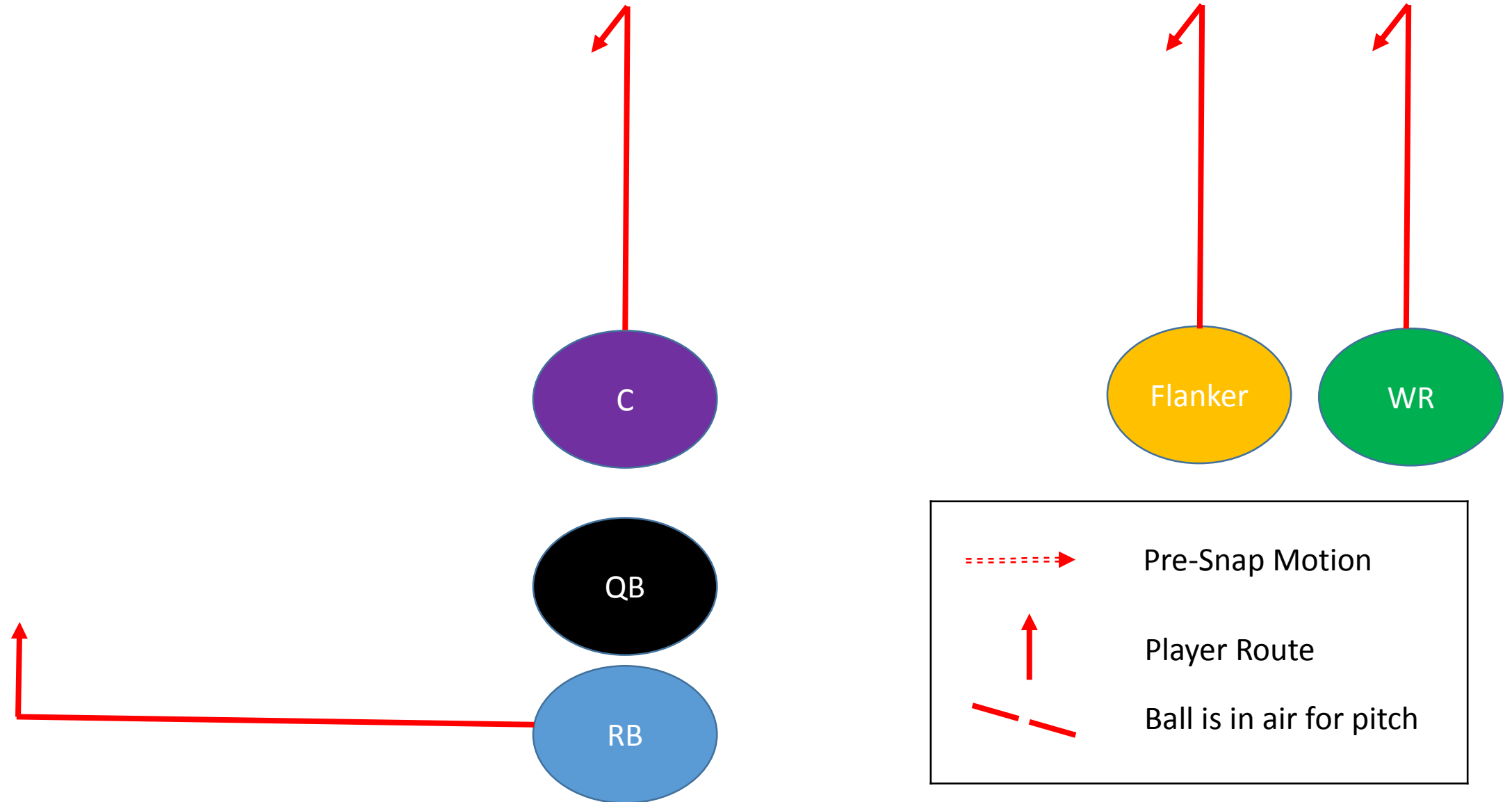

TWINS RIGHT, ALL CURL

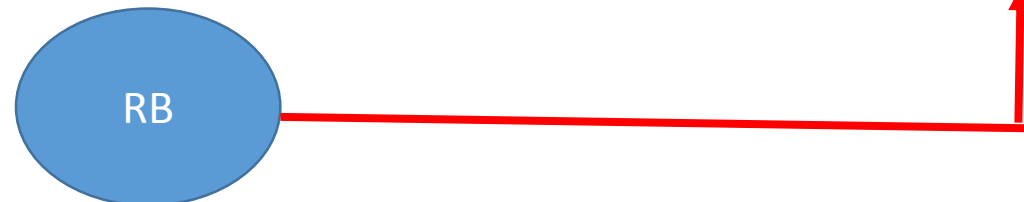
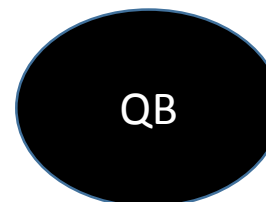
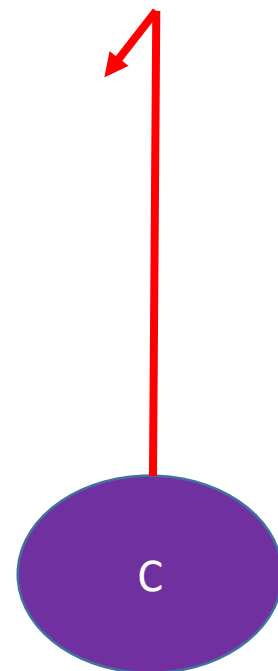
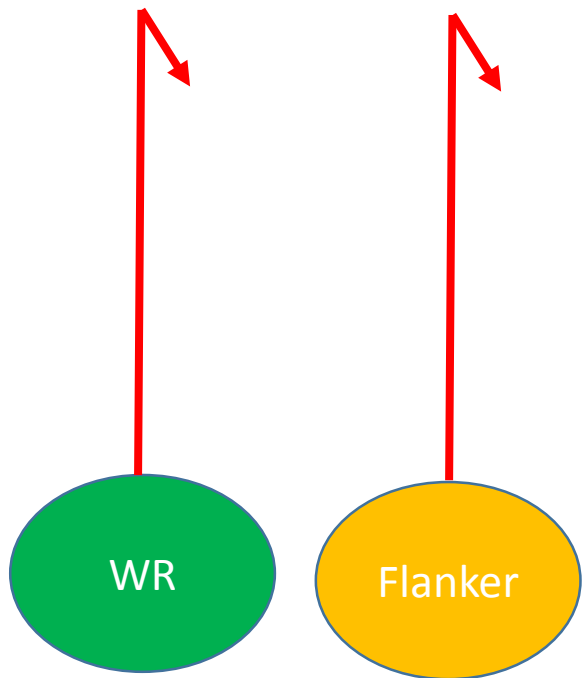

TWINS LEFT, ALL CURL

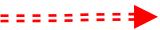

	Pre-Snap Motion
	Player Route
	Ball is in air for pitch

BALANCED, FLANKER POST

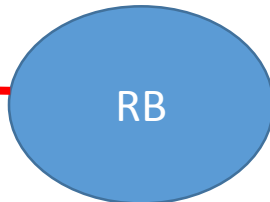
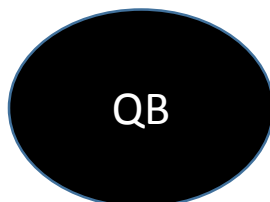
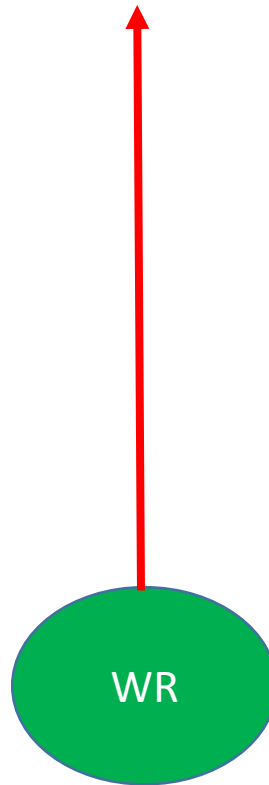
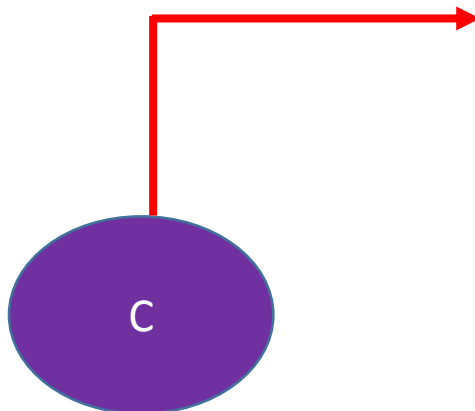
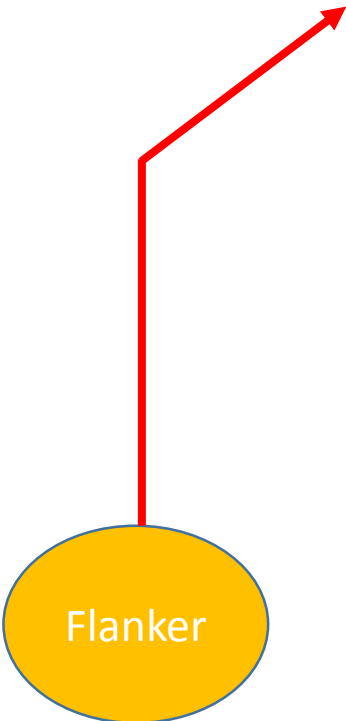

	Pre-Snap Motion
	Player Route
	Ball is in air for pitch

TWINS RIGHT, FLANKER POST

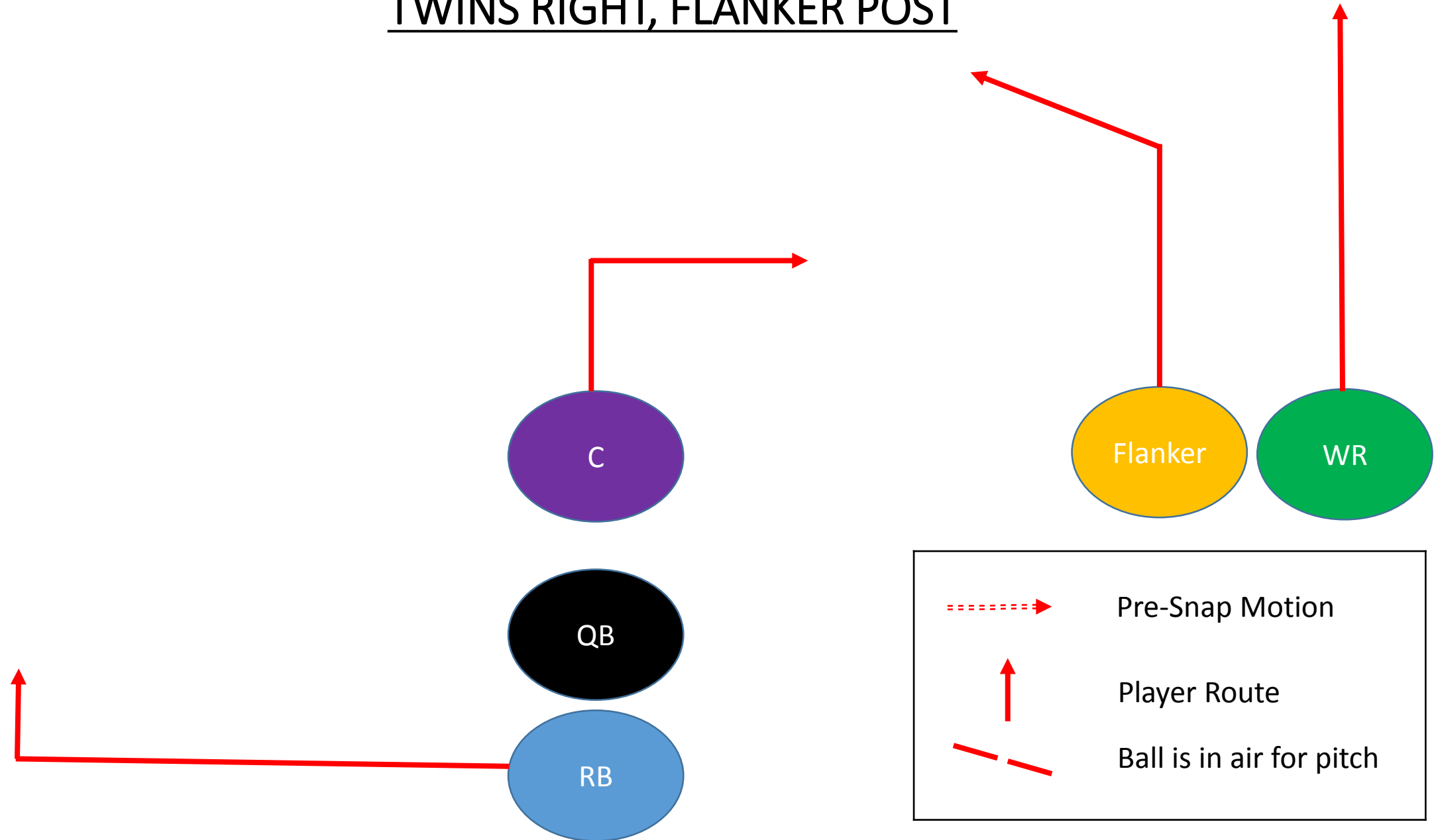

TWINS RIGHT, WIDE RECEIVER RUB

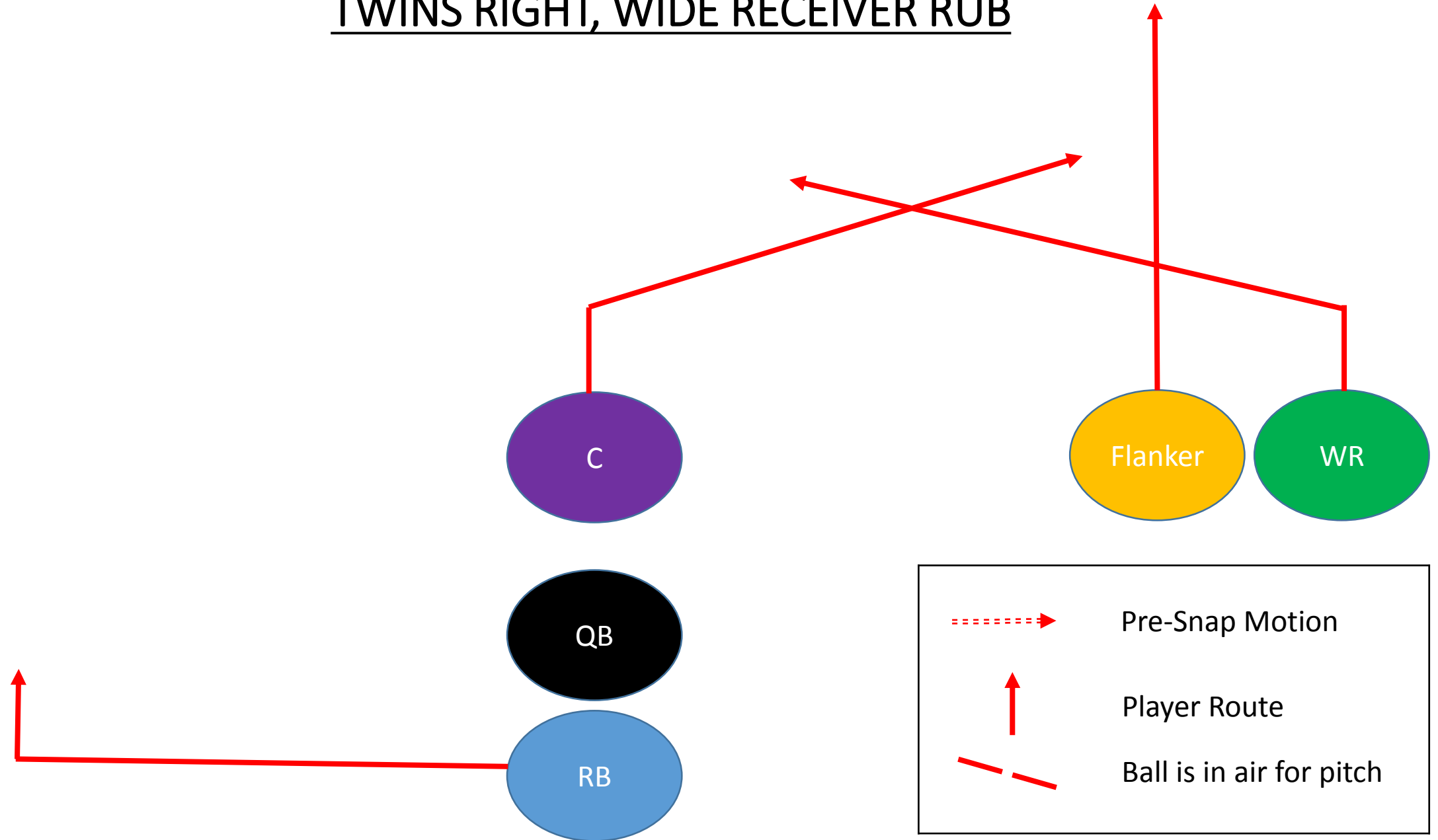



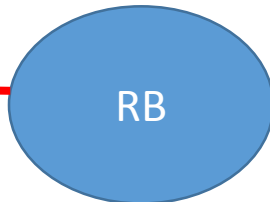
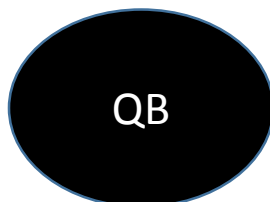
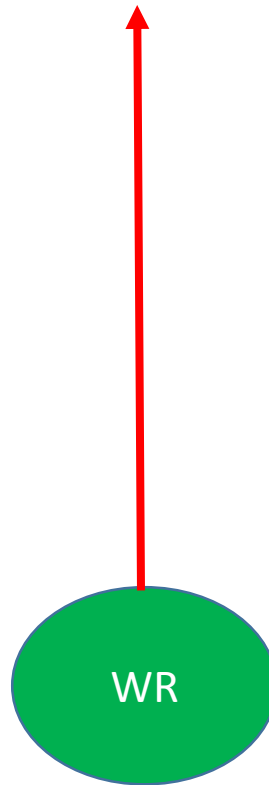
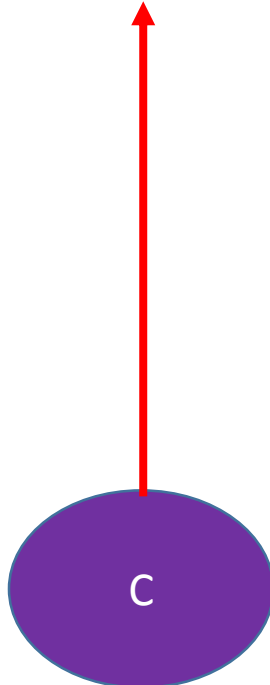
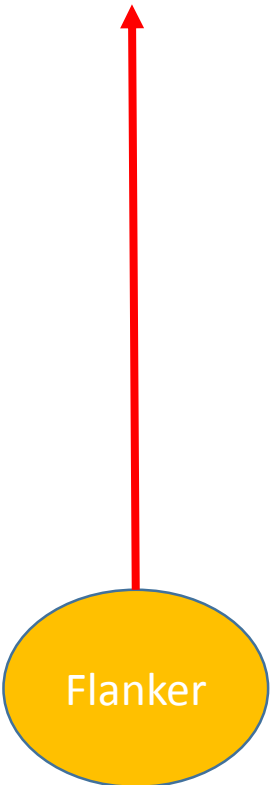

BALANCED, ALL GO

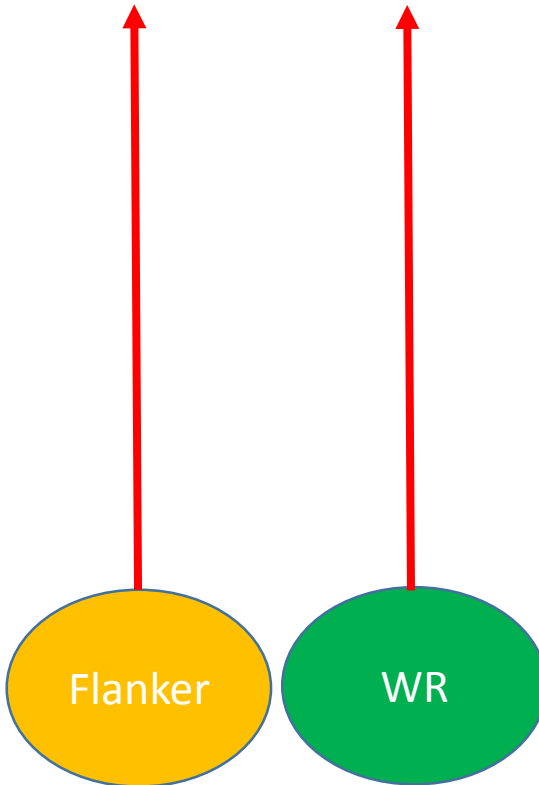
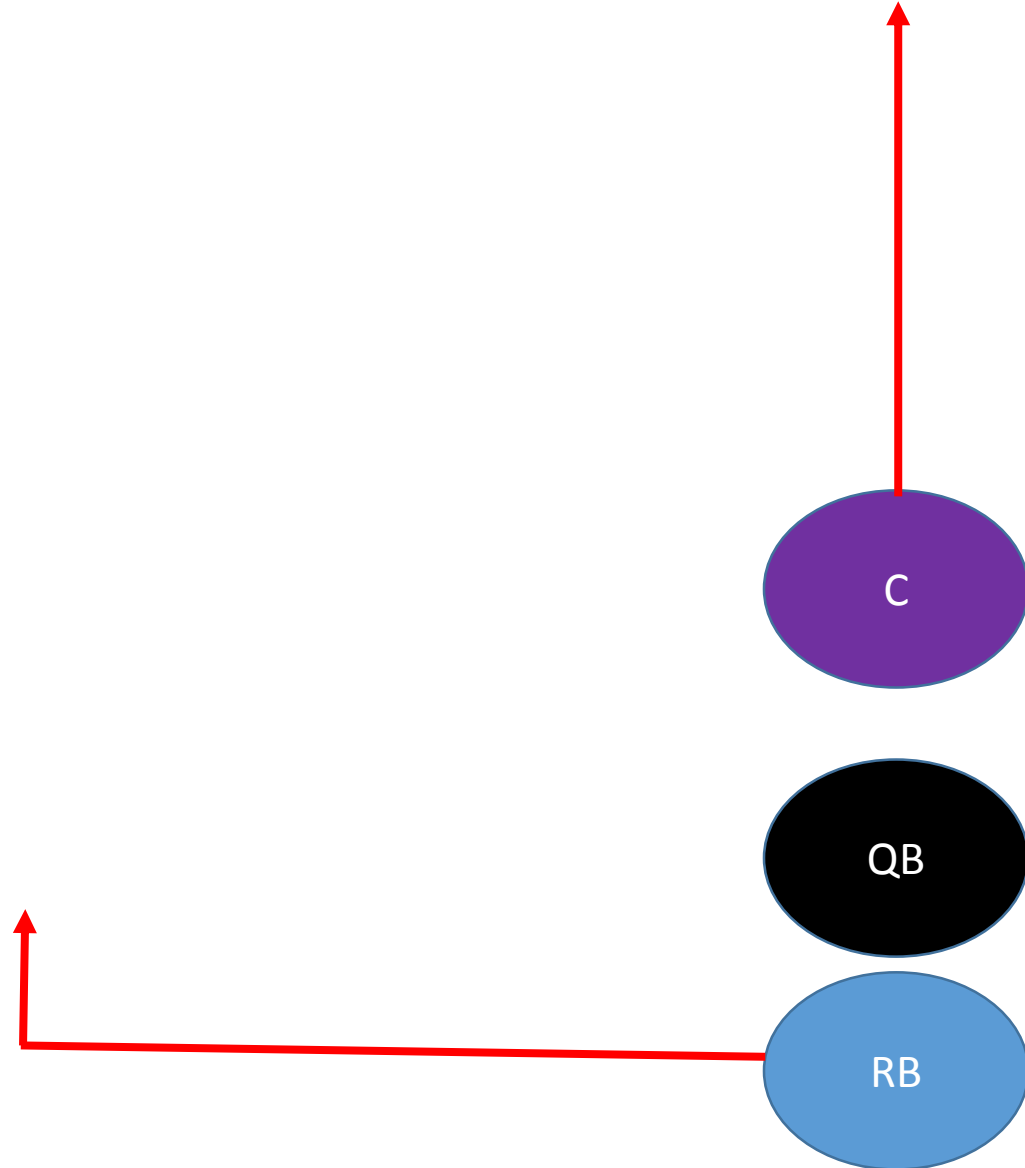

	Pre-Snap Motion
	Player Route
	Ball is in air for pitch



TWINS RIGHT, ALL GO

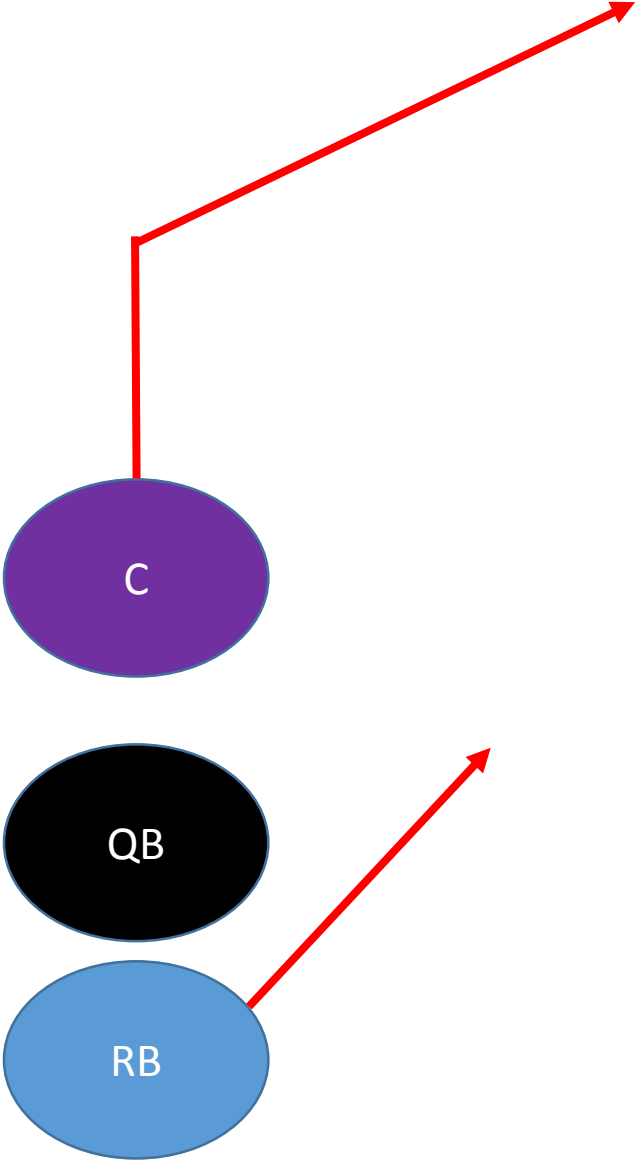
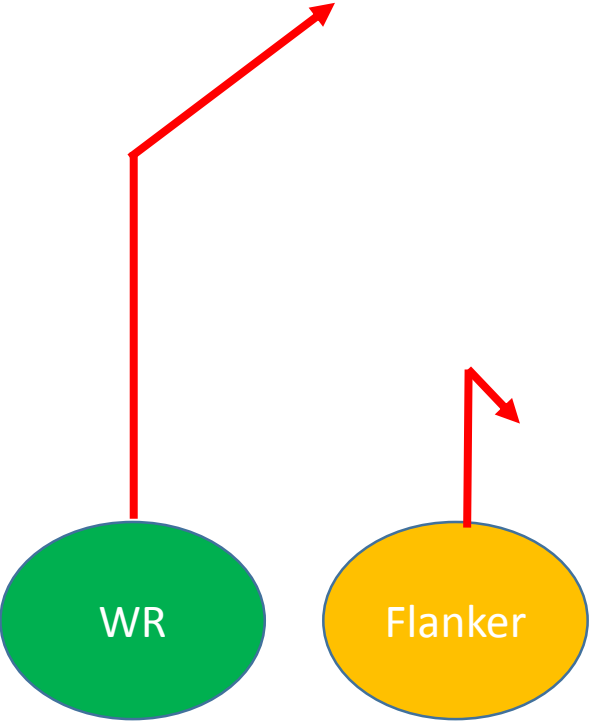

	Pre-Snap Motion
	Player Route
	Ball is in air for pitch

TWINS LEFT, RUNNING BACK PASS



	Pre-Snap Motion
	Player Route
	Ball is in air for pitch

Cover 1 Zone Defense

